

# 3

TEVI

TEVI SUDATE ROTUNDE DIN BANDA LAMINATA  
LA CALD NEGRE SI DECAPATE  
TEVI ROTUNDE SERIE SPECIALA  
TEVI ROTUNDE PENTRU INSTALATII  
TEVI ROTUNDE LAMINATE LA CALD  
TEVI ROTUNDE CU PERETI GROSII  
(APLICATII MECANICE)  
TEVI SUDATE TRIUNGHILARE,  
SEMIOVALE SI OVALE  
TEVI SUDATE PATRATE DIN BANDA  
LAMINATA LA CALD  
TEVI SUDATE RECTANGULARE DIN  
BANDA LAMINATA LA CALD  
TEVI PENTRU FERESTRE SI PORTI (TAMPLARIE)  
NEGRE, DECAPATE SI ZINCATE

### 3) TEVI

#### TEVI SUDATE ROTUNDE DIN BANDA LAMINATA LA CALD NEGRE SI DECAPATE

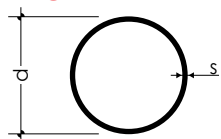

| Diametrul d (mm) | Grosime s (mm) / Greutate (Kg/m) |      |      |      |      |
|------------------|----------------------------------|------|------|------|------|
|                  | 1,5                              | 2    | 3    | 4    | 5    |
| 10               | 0,32                             |      |      |      |      |
| 12               | 0,37                             |      |      |      |      |
| 14               | 0,49                             |      |      |      |      |
| 15               | 0,59                             |      |      |      |      |
| 16               | 0,54                             | 0,69 |      |      |      |
| 18               | 0,61                             | 0,79 |      |      |      |
| 20               | 0,68                             | 0,89 |      |      |      |
| 22               | 0,76                             | 0,99 |      |      |      |
| 25               | 0,87                             | 1,13 | 1,63 |      |      |
| 28               | 0,98                             | 1,28 | 1,65 |      |      |
| 30               | 1,05                             | 1,38 | 2,00 |      |      |
| 32               | 1,13                             | 1,48 | 2,15 |      |      |
| 33               | 1,18                             | 1,55 | 2,25 | 2,91 |      |
| 35               | 1,24                             | 1,63 | 2,37 |      |      |
| 38               | 1,35                             | 1,78 | 2,59 | 3,38 |      |
| 40               | 1,42                             | 1,88 | 2,74 | 3,55 |      |
| 42               | 1,50                             | 1,97 | 2,89 | 3,75 |      |
| 45               | 1,61                             | 2,12 | 3,11 | 4,05 |      |
| 48               | 1,72                             | 2,27 | 3,33 | 4,38 | 5,22 |
| 50               | 1,79                             | 2,37 | 3,48 | 4,54 |      |
| 55               | 1,98                             | 2,61 | 3,85 | 5,03 |      |
| 57               | 2,05                             | 2,71 | 4,00 | 5,23 |      |
| 60               | 2,16                             | 2,86 | 4,22 | 5,52 | 6,61 |
| 63               | 2,27                             | 3,01 | 4,40 | 5,70 |      |
| 65               | 2,35                             | 3,11 | 4,59 | 6,02 |      |
| 70               | 2,53                             | 3,35 | 4,96 | 6,51 | 8,02 |
| 76               | 2,76                             | 3,65 | 5,40 | 7,10 | 8,76 |
| 80               | 2,90                             | 3,85 | 5,70 | 7,50 | 9,26 |

| Diametrul d (mm) | Grosime s (mm) / Greutate (Kg/m) |       |       |       |       |       |
|------------------|----------------------------------|-------|-------|-------|-------|-------|
|                  | 2                                | 3     | 4     | 5     | 6     | 8     |
| 89               | 5,33                             | 8,38  | 10,36 | 12,29 | 14,17 |       |
| 102              | 6,13                             | 9,67  | 11,96 | 14,37 | 16,41 |       |
| 108              |                                  | 10,26 | 12,70 | 15,09 | 17,44 |       |
| 114,3            |                                  | 10,85 | 13,44 | 15,99 | 18,49 |       |
| 121              |                                  | 11,45 | 14,31 | 17,02 | 19,69 |       |
| 127              |                                  | 12,13 | 15,04 | 17,90 | 20,74 |       |
| 133              |                                  | 12,73 | 15,78 | 18,79 | 21,77 |       |
| 139,7            |                                  | 13,39 | 16,61 | 19,78 | 22,93 |       |
| 152              |                                  | 14,60 | 18,13 | 21,60 | 25,00 |       |
| 159              |                                  | 15,29 | 18,99 | 22,64 | 26,24 |       |
| 168,3            |                                  | 16,18 | 20,10 | 23,97 | 27,79 | 31,64 |
| 193,7            |                                  | 18,55 | 23,06 | 27,52 | 31,94 | 36,66 |
| 219              |                                  | 21,21 | 26,39 | 31,06 | 36,59 | 41,67 |
| 244,5            |                                  | 23,75 | 29,57 | 35,33 | 41,05 | 46,69 |
| 273              |                                  | 26,54 | 33,05 | 39,55 | 45,97 | 52,31 |
| 323,9            |                                  | 31,56 | 39,32 | 46,30 | 54,70 | 62,36 |
| 339,7            |                                  | 33,15 | 41,32 | 49,44 | 57,50 |       |
| 355,6            |                                  | 34,72 | 43,28 | 51,79 | 60,25 | 68,62 |
| 406,4            |                                  | 39,74 | 49,55 | 59,32 | 69,03 | 78,65 |
| 457,2            |                                  |       | 55,83 | 66,84 | 77,81 | 93    |
| 508              |                                  |       | 62,10 | 74,37 | 86,59 | 103   |

#### TEVI ROTUNDE SERIE SPECIALA

| Diametrul d (mm) | Grosime s (mm) / Greutate (Kg/m) |       |       |
|------------------|----------------------------------|-------|-------|
|                  | 1,5                              | 2     | 3     |
| 100              | 3,67                             | 4,90  | 7,35  |
| 120              | 4,41                             | 5,88  | 8,82  |
| 150              | 5,51                             | 7,35  | 11,02 |
| 180              | 6,61                             | 8,82  | 13,23 |
| 200              | 7,35                             | 9,80  | 14,70 |
| 220              | 8,08                             | 10,78 | 16,16 |
| 250              | 9,08                             | 12,90 | 18,15 |
| 300              | 11,0                             | 15,20 | 21,78 |

## TEVI ROTUNDE PENTRU INSTALATII

NEGRE, ZINCATE - FILETATE SI MUFATE

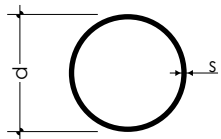

| Diametrul d (inci) | Diametrul d (mm) | Grosime s (mm) | Greutate negre (Kg/m) | Greutate zincate (Kg/m) |
|--------------------|------------------|----------------|-----------------------|-------------------------|
| 3/8                | 16,75            | 2,00           | 0,74                  | 0,81                    |
| 1/2                | 21,25            | 2,30           | 0,95                  | 1,18                    |
| 3/4                | 26,75            | 2,50           | 1,41                  | 1,51                    |
| 1                  | 33,48            | 2,50           | 2,01                  | 2,12                    |
| 1 1/4              | 42,25            | 2,50           | 2,58                  | 2,71                    |
| 1 1/2              | 48,25            | 3,00           | 3,37                  | 3,32                    |
| 2                  | 60,00            | 3,00           | 4,22                  | 4,28                    |
| 2 1/2              | 76,00            | 3,00           | 5,40                  | 6,04                    |
| 3                  | 88,90            | 3,00           | 6,36                  | 7,14                    |
| 3 1/2              | 101,60           | 3,00           | 7,32                  | 9,10                    |
| 4                  | 114,30           | 3,00           | 8,21                  | 10,30                   |
| 4 1/2              | 127,00           | 4,00           | 12,20                 |                         |
| 5                  | 139,70           | 4,00           | 13,50                 |                         |
| 5 1/2              | 152,00           | 4,50           | 16,36                 |                         |
| 6                  | 168,00           | 4,50           | 18,20                 |                         |
| 8                  | 219,00           | 4,50           | 23,70                 |                         |

## TEVI ROTUNDE LAMINATE LA CALD

NEGRE, TESTATE PANA LA 50 ATM.

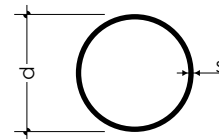

| Diametrul d (inci) | Diametrul s (mm) | Grosime (mm) | Greutate (Kg/m) |
|--------------------|------------------|--------------|-----------------|
| 1/8                | 10,00            | 1,80         | 0,372           |
| 1/4                | 13,25            | 2,00         | 0,577           |
| 3/8                | 16,75            | 2,00         | 0,753           |
| 1/2                | 21,25            | 2,35         | 1,110           |
| 3/4                | 26,75            | 2,35         | 1,420           |
| 1                  | 33,48            | 2,90         | 2,230           |
| 1 1/4              | 42,25            | 2,90         | 2,870           |
| 1 1/2              | 48,25            | 2,90         | 3,300           |
| 2                  | 60,00            | 3,25         | 4,630           |
| 2 1/2              | 76,00            | 3,25         | 5,930           |
| 3                  | 89,00            | 3,65         | 7,820           |
| 3 1/2              | 102,00           | 3,65         | 8,950           |
| 4                  | 114,30           | 4,05         | 11,300          |
| 5                  | 139,07           | 4,85         | 16,700          |
| 6                  | 168,00           | 4,85         | 19,800          |

## TEVI ROTUNDE CU PERETI GROSII

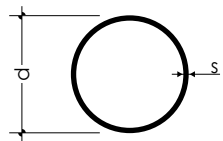

### PENTRU APLICATII MECANICE

| Diametrul d (mm) | Grosime s (mm) / Greutate (Kg/m) |      |      |      |      |      |      |      |      |
|------------------|----------------------------------|------|------|------|------|------|------|------|------|
|                  | 8                                | 10   | 12,5 | 14,2 | 16   | 17,5 | 20   | 25   | 30   |
| 48,3             | 7,93                             | 9,45 |      |      |      |      |      |      |      |
| 51               | 8,43                             | 10,1 | 11,9 |      |      |      |      |      |      |
| 54               | 9,04                             | 10,9 | 12,9 |      |      |      |      |      |      |
| 57               | 9,65                             | 11,6 | 13,8 |      |      |      |      |      |      |
| 60,3             | 10,3                             | 12,4 | 14,8 |      |      |      |      |      |      |
| 63,5             | 10,9                             | 13,2 | 15,8 |      |      |      |      |      |      |
| 67               | 11,6                             | 14,1 | 16,3 | 18,3 | 20,1 |      |      |      |      |
| 70               | 12,2                             | 14,8 | 17,8 | 19,3 | 21,2 |      |      |      |      |
| 76,1             | 13,4                             | 16,3 | 19,7 | 21,4 | 23,7 |      |      |      |      |
| 82,5             | 14,6                             | 17,9 | 21,7 | 23,8 | 26,2 | 28,8 | 30,8 |      |      |
| 88,9             | 15,9                             | 19,5 | 23,7 | 25,9 | 28,7 | 31,5 | 34,0 |      |      |
| 95               | 17,2                             | 21,0 | 24,6 | 28,0 | 31,2 | 34,2 | 37,0 |      |      |
| 101,6            | 18,4                             | 22,6 | 27,6 | 30,4 | 33,7 | 37,3 | 40,2 | 47,5 |      |
| 108              | 19,6                             | 24,2 | 29,6 | 32,5 | 36,2 | 40,4 | 43,4 | 51,4 |      |
| 114,3            | 20,9                             | 25,7 | 31,6 | 34,3 | 38,6 | 42,6 | 46,5 | 55,3 |      |
| 121              | 21,3                             | 27,4 | 32,3 | 36,9 | 41,4 | 45,7 | 49,8 | 60,1 | 67,3 |
| 127              | 23,4                             | 28,9 | 35,5 | 39,0 | 43,6 | 48,4 | 52,8 | 63,2 | 71,8 |
| 133              | 24,6                             | 30,3 | 37,4 | 41,4 | 46,1 | 51,0 | 55,7 | 67,1 | 76,2 |
| 139,7            | 25,9                             | 32,0 | 39,5 | 43,5 | 48,6 | 54,2 | 59,0 | 71,1 | 81,2 |
| 146              | 27,2                             | 33,5 | 39,7 | 45,6 | 51,3 | 56,8 | 62,2 | 74,8 | 85,2 |
| 152,4            | 28,4                             | 35,1 | 43,4 | 47,6 | 53,6 | 59,5 | 65,3 | 79,0 | 90,6 |
| 159              | 28,4                             | 36,7 | 45,4 | 50,1 | 56,2 | 62,6 | 68,6 | 83,0 | 95,4 |
| 168,3            |                                  | 39,0 | 48,4 | 53,5 | 59,9 | 66,5 | 73,1 | 89,9 | 102  |
| 177,8            |                                  | 41,4 | 51,3 | 56,6 | 63,6 | 71,0 | 77,8 | 94,8 | 109  |
| 193,7            |                                  | 45,3 | 56,2 | 62,0 | 69,8 | 78,0 | 85,7 | 105  | 121  |
| 203              |                                  | 47,5 | 58,5 | 65,3 | 73,8 | 82,1 | 90,3 | 110  | 128  |

## TEVI ROTUNDE CU PERETI GROSII

| Diametrul d (mm) | Grosime s (mm) / Greutate (Kg/m) |      |      |       |      |     |     |     |     |
|------------------|----------------------------------|------|------|-------|------|-----|-----|-----|-----|
|                  | 12,5                             | 14,2 | 16   | 17,5  | 20   | 25  | 30  | 35  | 40  |
| 219,1            | 64,1                             | 71,0 | 79,8 | 89,0  | 98,2 | 120 | 140 | 159 | 177 |
| 229              | 66,5                             | 74,2 | 84,0 | 93,7  | 103  | 126 | 147 | 167 | 186 |
| 244,5            | 72,0                             | 80,0 | 89,8 | 103,5 | 111  | 136 | 151 | 181 | 202 |
| 254              | 75,0                             | 82,9 | 83,9 | 105   | 115  | 141 | 166 | 189 | 211 |
| 273              | 80,9                             | 89,5 | 101  | 113   | 125  | 154 | 180 | 205 | 230 |
| 298,5            | 88,8                             | 98,5 | 111  | 124   | 137  | 170 | 199 | 227 | 255 |
| 305              | 90,2                             | 100  | 113  | 127   | 141  | 173 | 203 | 233 | 261 |
| 323,9            | 96,7                             | 107  | 121  | 135   | 150  | 186 | 217 | 249 | 280 |
| 330              |                                  | 109  | 124  | 138   | 153  | 189 | 222 | 255 | 286 |
| 343              |                                  | 114  | 129  | 144   | 159  | 197 | 232 | 266 | 299 |
| 355,6            |                                  | 118  | 134  | 150   | 166  | 205 | 241 | 277 | 312 |
| 368              |                                  | 122  | 139  | 155   | 172  | 213 | 250 | 287 | 324 |
| 381              |                                  | 127  | 144  | 161   | 178  | 221 | 260 | 299 | 366 |
| 394              |                                  | 131  | 149  | 167   | 184  | 229 | 269 | 310 | 349 |
| 406,4            |                                  | 135  | 154  | 172   | 190  | 237 | 278 | 320 | 361 |
| 419              |                                  | 140  | 159  | 178   | 197  | 245 | 288 | 331 | 374 |

## TEVI SUDATE TRIUNGHILARE

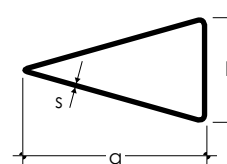

| Dimensiuni axb (mm) | Grosime s (mm) | Greutate (Kg/m) |
|---------------------|----------------|-----------------|
| 30x15               | 1,5            | 0,87            |
| 40x22               | 1,5            | 1,24            |

## TEVI SUDATE OVALE

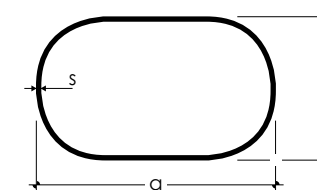

| Dimensiuni axb (mm) | Grosime s (mm) | Greutate (Kg/m) |
|---------------------|----------------|-----------------|
| 30x15               | 1,5            | 0,87            |
| 40x20               | 1,5            | 1,12            |
| 50x10               | 1,5            | 1,25            |
| 50x25               | 1,5            | 1,54            |
| 60x30               | 1,5            | 2,12            |

## TEVI SUDATE SEMIOVALE

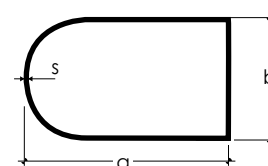

| Dimensiuni axb (mm) | Grosime s (mm) | Greutate (Kg/m) |
|---------------------|----------------|-----------------|
| 40x20               | 1,5            | 1,11            |
| 40x25               | 1,5            | 1,22            |

## TEVI SUDATE PATRATE DIN BANDA LAMINATA LA CALD

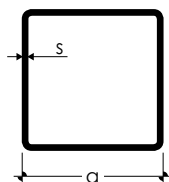

NEGRE SI DECAPATE L= 6 SI 12 M

| a<br>(mm) | Decapat | Grosime s (mm) / Greutate (Kg/m) |       |       |       |       |       |       |    |
|-----------|---------|----------------------------------|-------|-------|-------|-------|-------|-------|----|
|           |         | 1,5                              | 2     | 3     | 4     | 5     | 6     | 8     | 10 |
| 10x10     | 0,34    |                                  |       |       |       |       |       |       |    |
| 12x12     | 0,43    |                                  |       |       |       |       |       |       |    |
| 15x15     | 0,57    | 0,70                             |       |       |       |       |       |       |    |
| 20x20     | 0,81    | 1,02                             | 1,36  |       |       |       |       |       |    |
| 25x25     | 1,05    | 1,34                             | 1,83  |       |       |       |       |       |    |
| 30x30     | 1,28    | 1,65                             | 2,30  | 2,84  |       |       |       |       |    |
| 35x35     | 1,52    | 1,96                             | 2,77  | 3,46  |       |       |       |       |    |
| 40x40     | 1,75    | 2,28                             | 3,24  | 4,09  | 4,83  |       |       |       |    |
| 45x45     | 1,99    | 2,6                              | 3,71  | 4,72  | 5,61  |       |       |       |    |
| 50x50     | 2,22    | 2,91                             | 4,19  | 5,35  | 6,4   |       |       |       |    |
| 55x55     |         |                                  | 4,52  |       |       |       |       |       |    |
| 60x60     | 2,69    | 3,54                             | 5,13  | 6,51  | 7,97  | 10,15 |       |       |    |
| 65x65     | 2,93    | 3,85                             | 5,60  | 7,24  | 8,75  | 10,34 |       |       |    |
| 70x70     |         | 4,16                             | 6,07  | 7,86  | 9,54  | 11,10 |       |       |    |
| 80x80     |         | 4,79                             | 7,02  | 9,12  | 11,11 | 12,99 | 16,38 |       |    |
| 90x90     |         | 5,42                             | 7,96  | 10,38 | 12,68 | 14,87 | 18,89 |       |    |
| 100x100   |         | 6,07                             | 8,90  | 11,64 | 14,26 | 16,76 | 21,41 | 24,89 |    |
| 110x110   |         |                                  | 9,84  | 12,89 | 15,83 | 18,64 | 23,93 | 28,03 |    |
| 120x120   |         |                                  | 10,79 | 14,15 | 17,4  | 20,53 | 26,44 | 31,17 |    |
| 140x140   |         |                                  | 12,72 | 16,76 | 20,52 | 24,28 | 31,43 | 37,45 |    |
| 150x150   |         |                                  | 13,62 | 17,92 | 22,11 | 26,19 | 33,98 | 40,59 |    |
| 160x160   |         |                                  | 14,61 | 19,27 | 23,66 | 28,04 | 34,46 | 43,73 |    |
| 175x175   |         |                                  | 15,98 | 21,07 | 26,04 | 30,90 | 40,27 | 48,44 |    |
| 200x200   |         |                                  | 17,19 | 24,29 | 29,94 | 35,58 | 46,51 | 56,29 |    |
| 220x220   |         |                                  |       | 26,73 | 33,12 | 39,39 | 51,59 | 62,57 |    |
| 250x250   |         |                                  |       | 30,57 | 37,79 | 45,00 | 59,07 | 71,99 |    |
| 260x260   |         |                                  |       | 31,76 | 39,41 | 46,94 | 61,61 | 75,13 |    |
| 300x300   |         |                                  |       |       | 45,64 | 54,42 | 71,63 | 87,69 |    |

## TEVI SUDATE RECTANGULARE DIN BANDA LAMINATA LA CALD

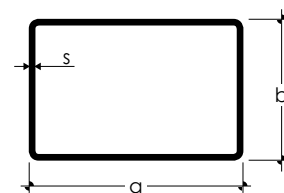

NEGRE SI DECAPATE L= 6 SI 12 M

| a x b<br>(mm) | Decapat | Grosime s (mm) / Greutate (Kg/m) |      |      |      |   |
|---------------|---------|----------------------------------|------|------|------|---|
|               |         | 1,5                              | 2    | 2,5  | 3    | 4 |
| 15x10         | 0,52    |                                  |      |      |      |   |
| 20x10         | 0,64    | 0,81                             |      |      |      |   |
| 20x15         | 0,75    | 0,97                             |      |      |      |   |
| 25x10         | 0,75    | 0,97                             |      |      |      |   |
| 25x15         | 0,87    | 1,13                             |      |      |      |   |
| 30x10         | 0,87    | 1,13                             |      |      |      |   |
| 30x15         | 0,99    | 1,29                             | 1,44 | 1,65 |      |   |
| 30x20         | 1,11    | 1,44                             | 1,77 | 2,07 |      |   |
| 30x25         | 1,22    | 1,60                             | 1,96 | 2,31 |      |   |
| 35x10         | 0,99    | 1,29                             |      |      |      |   |
| 35x15         | 1,11    | 1,44                             | 1,77 | 2,07 |      |   |
| 35x20         | 1,22    | 1,60                             | 1,96 | 2,31 |      |   |
| 35x25         | 1,34    | 1,76                             | 2,16 | 2,54 |      |   |
| 40x10         | 1,11    | 1,44                             |      |      |      |   |
| 40x15         | 1,22    | 1,60                             | 1,84 | 2,13 |      |   |
| 40x20         | 1,34    | 1,76                             | 2,16 | 2,54 |      |   |
| 40x25         | 1,46    | 1,91                             | 2,34 | 2,78 |      |   |
| 40x30         | 1,58    | 2,07                             | 2,55 | 3,01 | 3,83 |   |
| 45x10         | 1,22    | 1,52                             |      |      |      |   |
| 45x15         | 1,34    | 1,76                             |      |      |      |   |
| 45x20         | 1,46    | 1,91                             | 2,23 | 2,78 |      |   |
| 45x25         | 1,58    | 2,07                             | 2,42 | 3,01 |      |   |
| 50x10         | 1,34    | 1,76                             |      |      |      |   |
| 50x15         | 1,46    | 1,92                             |      |      |      |   |

## TEVI SUDATE RECTANGULARE DIN BANDA LAMINATA LA CALD

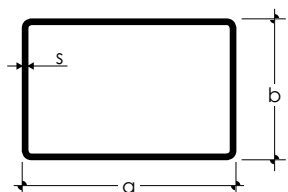

**NEGRE SI DECAPATE L= 6 SI 12 M**

| a x b<br>(mm) | Grosime s (mm) / Greutate (Kg/m) |      |      |      |      |       |
|---------------|----------------------------------|------|------|------|------|-------|
|               | 1,5                              | 2    | 3    | 4    | 5    | 6     |
| 50x20         | 1,58                             | 2,07 | 3,01 |      |      |       |
| 50x25         | 1,77                             | 2,23 | 3,25 |      |      |       |
| 50x30         | 1,81                             | 2,39 | 3,49 | 4,52 |      |       |
| 50x40         | 2,05                             | 2,70 | 3,96 | 5,15 |      |       |
| 60x10         | 1,58                             | 2,07 |      |      |      |       |
| 60x15         | 1,77                             | 2,23 |      |      |      |       |
| 60x20         | 1,81                             | 2,39 | 3,30 |      |      |       |
| 60x25         | 1,87                             | 2,43 | 3,58 |      |      |       |
| 60x30         | 1,99                             | 2,59 | 3,71 | 4,72 |      |       |
| 60x40         | 2,22                             | 2,91 | 4,19 | 5,35 | 6,39 |       |
| 60x50         | 2,46                             | 3,22 | 4,66 | 5,98 | 8,02 |       |
| 70x20         | 1,99                             | 2,59 | 3,71 |      |      |       |
| 70x25         | 2,10                             | 2,75 | 3,95 |      |      |       |
| 70x30         | 2,22                             | 2,91 | 4,19 | 5,35 |      |       |
| 70x40         | 2,46                             | 3,22 | 4,66 | 5,98 | 7,59 |       |
| 70x50         | 2,69                             | 3,53 | 5,13 | 6,61 | 7,97 | 9,21  |
| 80x15         | 2,10                             | 2,75 |      |      |      |       |
| 80x20         | 2,22                             | 2,91 | 4,19 |      |      |       |
| 80x25         | 2,34                             | 3,06 | 4,42 |      |      |       |
| 80x30         | 2,46                             | 3,33 | 4,56 | 5,98 |      |       |
| 80x40         | 2,69                             | 3,53 | 5,40 | 6,60 | 7,96 | 9,21  |
| 80x50         | 2,93                             | 3,85 | 5,60 | 7,24 |      |       |
| 80x60         |                                  | 4,16 | 6,07 | 7,86 | 9,54 | 11,10 |
| 90x30         |                                  | 3,56 | 5,19 | 6,71 |      |       |
| 90x40         |                                  | 3,85 | 5,60 | 7,24 |      |       |
| 90x50         |                                  | 4,16 | 6,07 | 7,86 |      |       |

| a x b<br>(mm) | Grosime s (mm) / Greutate (Kg/m) |       |       |       |       |       |       |
|---------------|----------------------------------|-------|-------|-------|-------|-------|-------|
|               | 2                                | 3     | 4     | 5     | 6     | 8     | 10    |
| 90x60         | 4,48                             | 6,54  | 8,49  |       |       |       |       |
| 100x20        | 3,57                             | 6,13  |       |       |       |       |       |
| 100x30        | 3,85                             | 5,60  | 7,24  |       |       |       |       |
| 100x40        | 4,16                             | 6,07  | 7,86  | 9,54  | 11,10 | 13,86 |       |
| 100x50        | 4,48                             | 6,54  | 8,49  | 10,32 | 12,04 | 15,12 |       |
| 100x60        | 4,79                             | 7,02  | 9,11  | 11,10 | 12,98 | 16,38 |       |
| 100x80        | 5,42                             | 7,96  | 10,38 | 12,58 | 14,87 |       |       |
| 110x50        | 4,79                             | 7,02  | 9,12  | 11,11 | 12,98 |       |       |
| 120x30        | 4,50                             | 6,60  | 8,59  |       |       |       |       |
| 120x40        | 4,52                             | 7,02  | 9,12  | 11,11 | 12,98 | 16,38 |       |
| 120x50        | 4,80                             | 7,23  | 9,64  |       |       |       |       |
| 120x60        | 5,41                             | 7,96  | 10,37 | 12,67 | 14,37 | 18,89 |       |
| 120x80        | 6,05                             | 8,90  | 11,63 | 14,24 | 16,76 | 21,41 |       |
| 130x50        | 5,42                             | 7,96  | 10,38 | 12,68 | 14,87 |       |       |
| 140x40        |                                  | 7,66  | 10,22 | 12,70 |       |       |       |
| 140x60        | 6,05                             | 8,90  | 11,64 | 14,25 | 16,76 | 21,41 |       |
| 140x70        | 6,36                             | 9,37  | 12,27 | 15,04 | 17,70 |       |       |
| 140x80        | 6,68                             | 9,84  | 12,89 | 15,83 | 18,64 |       |       |
| 150x30        | 5,52                             | 8,19  |       |       |       |       |       |
| 150x40        | 5,90                             | 8,80  | 10,81 | 13,43 |       |       |       |
| 150x50        | 6,05                             | 8,90  | 11,64 | 14,25 | 16,76 | 21,41 |       |
| 150x60        |                                  |       | 12,97 |       |       |       |       |
| 150x100       |                                  | 11,26 | 14,77 | 18,17 | 21,47 | 27,67 | 32,80 |
| 160x60        |                                  | 10,06 | 13,32 | 16,53 | 19,69 |       |       |
| 160x80        |                                  | 10,79 | 14,14 | 17,38 | 20,53 | 26,41 |       |
| 180x60        |                                  | 10,79 | 14,15 | 17,40 | 20,53 | 26,44 |       |
| 180x80        |                                  | 11,73 | 15,41 | 18,97 | 22,42 | 28,95 |       |
| 200x100       |                                  | 13,62 | 17,91 | 22,09 | 26,19 | 33,95 | 41,59 |
| 200x150       |                                  | 16,02 | 21,15 | 26,02 | 30,87 | 40,23 | 48,44 |
| 250x100       |                                  | 15,98 | 21,07 | 26,04 | 30,90 | 40,27 | 48,44 |

TEVI PENTRU FERESTRE (TAMPLARIE) GROSIME 1,5 MM - NEGRE SI ZINCATE

1A Kg/m 1,72

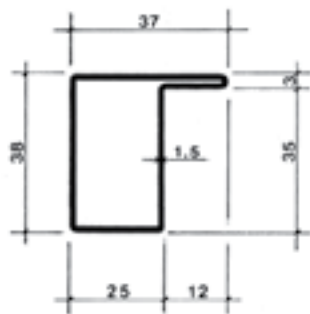

11A Kg/m 1,34

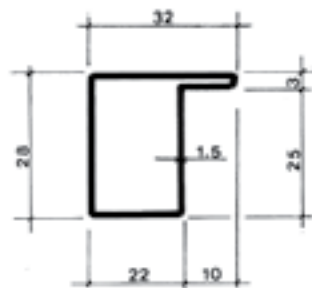

1B Kg/m 2,10

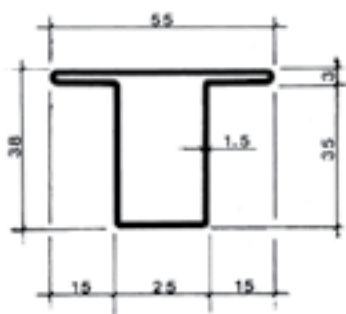

11B Kg/m 1,57

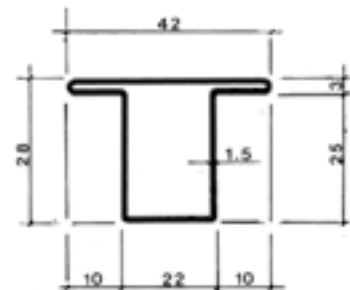

1C Kg/m 1,99

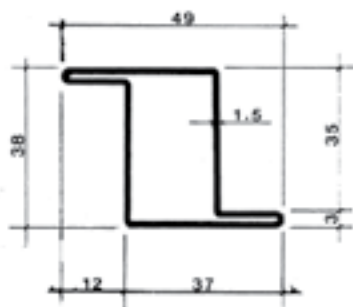

11C Kg/m 1,57

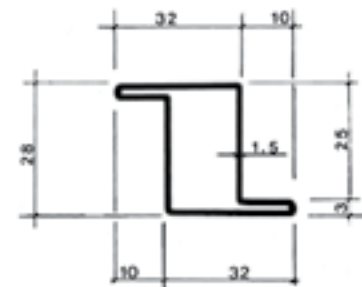

TEVI PENTRU FERESTRE (TAMPLARIE) GROSIME 1,5 MM - NEGRE SI ZINCATE

2A Kg/m 1,76

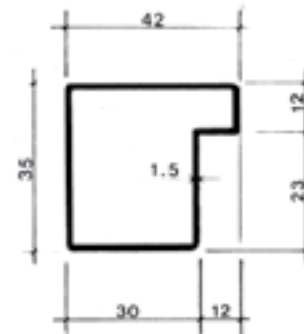

2N Kg/m 2,30

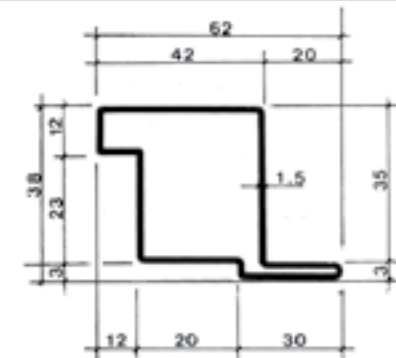

2B Kg/m 1,88

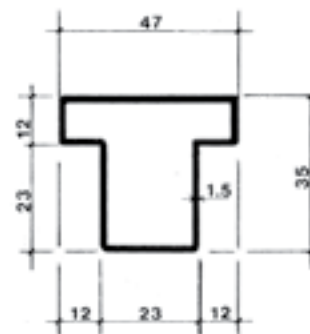

2T Kg/m 2,30

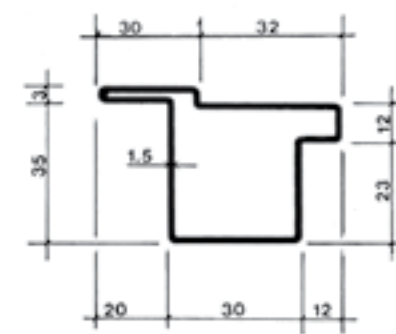

2Z Kg/m 1,88

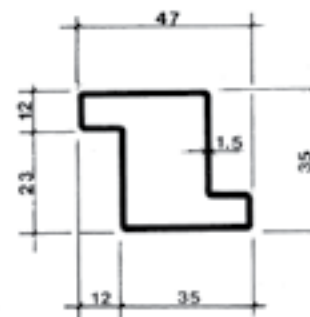

TEVI PENTRU FERESTRE (TAMPLARIE) GROSIME 1,5 MM - NEGRE SI ZINCATE

15A Kg/m 2,04

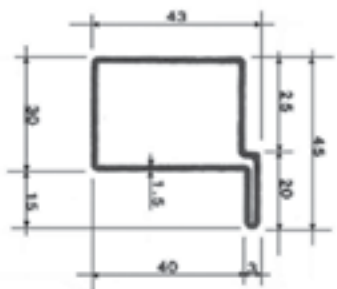

15B Kg/m 2,72

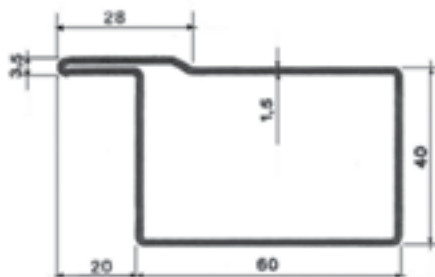

15T Kg/m 2,45

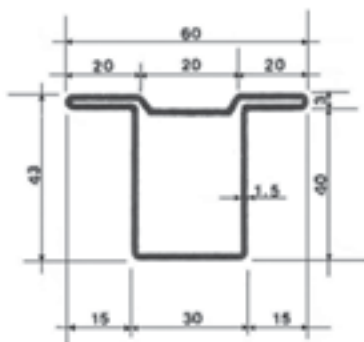

10B Kg/m 1,40

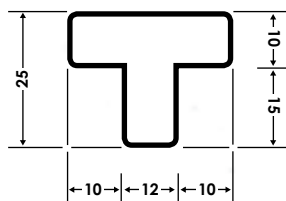

15Z Kg/m 2,45

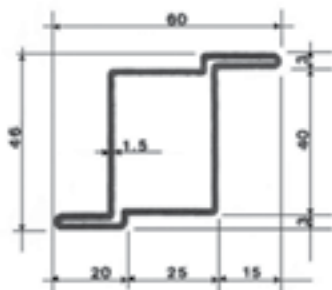

10A Kg/m 1,40

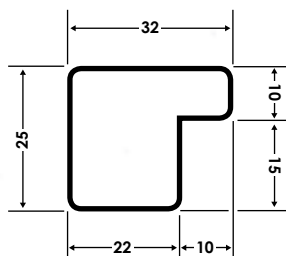

TEVI PENTRU PORTI GROSIME 1,5 MM - NEGRE SI ZINCATE

SF1 B Kg/m 2,15



16A Kg/m 2,33

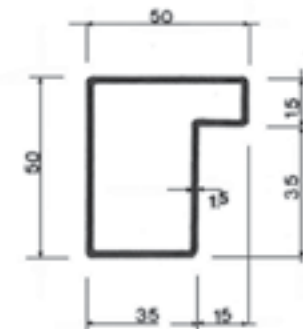

SF2 B Kg/m 2,52

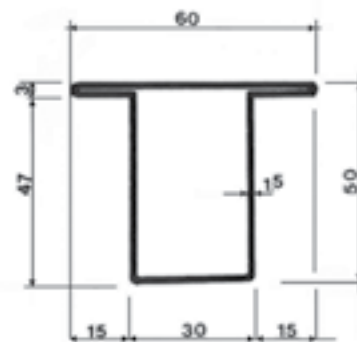

16B Kg/m 2,33

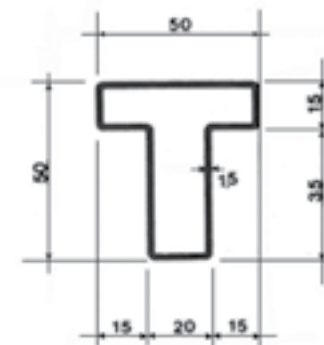

SF3 B Kg/m 2,52

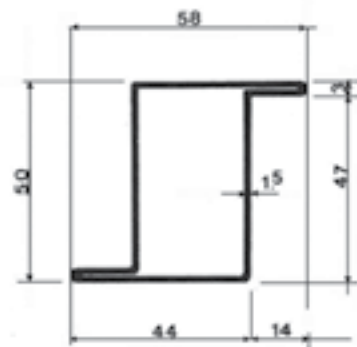

16Z Kg/m 2,56

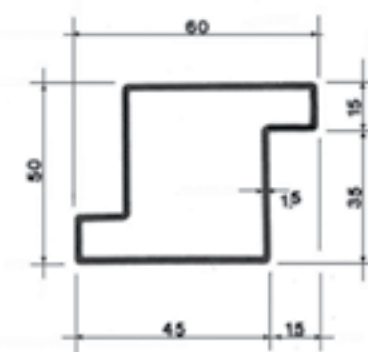



TEVI PENTRU PORTI GROSIME 1,5 MM - NEGRE SI ZINCATE

2D Kg/m 2,78

16D Kg/m 4,65

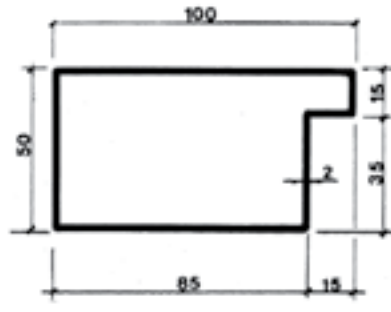
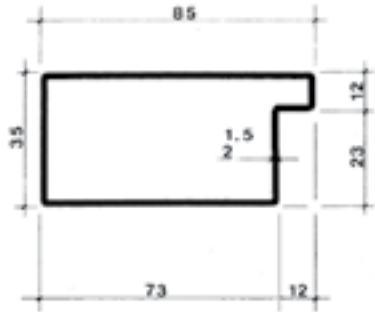

SFG 10 Kg/m 2,52

SFG 9 Kg/m 2,52

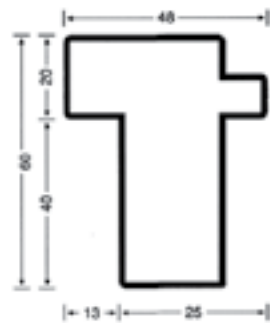
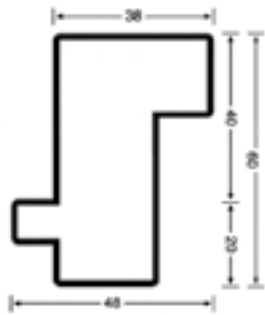

SFG 11 Kg/m 2,61

SFG 12 Kg/m 2,61

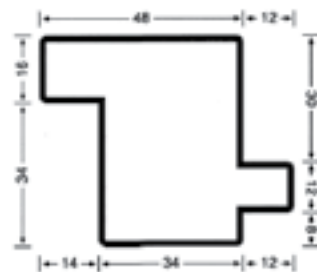
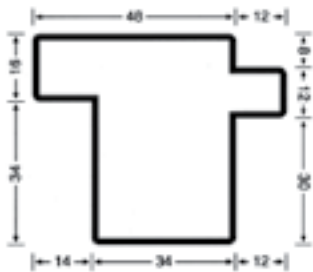

TEVI PENTRU PORTI GROSIME 1,5 MM - NEGRE SI ZINCATE

SFG 1 Kg/m 2,52

SFG 2 Kg/m 2,16

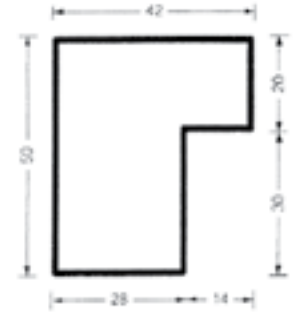
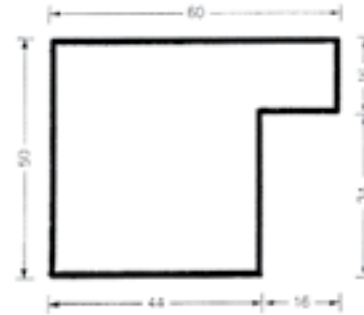

SFG 3 Kg/m 2,52

SFG 4 Kg/m 2,50

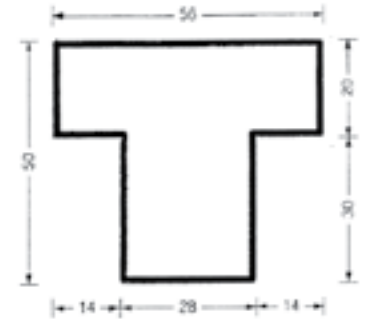
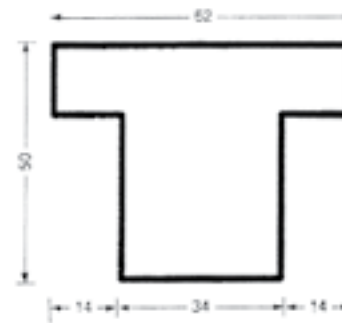

SFG 6 Kg/m 2,50

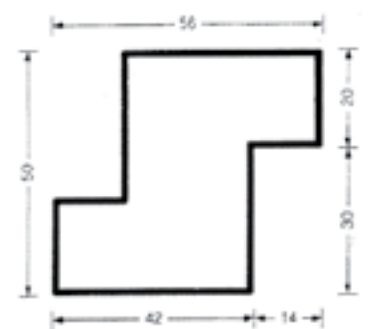

TEVI PENTRU MANA CURENTA GROSIME 1,5 MM - NEGRE SI ZINCATE

MT 5 - 15/10=Kg/m 1,65

MT 6 - 15/10=Kg/m 2,15

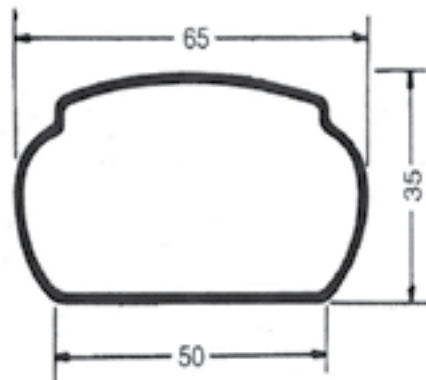
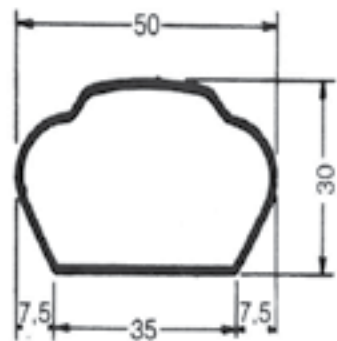

MT 8 - 15/10=Kg/m 1,87

MT 9 - 15/10=Kg/m 1,60

